



M-60 Xd

DSP Corrected Monitor System



Owners Manual



Safety instructions - Please Read First



The lightning flash with arrowhead symbol, within an equilateral triangle, is intended to alert the user to the presence of uninsulated "dangerous voltage" within the product's enclosure that may be of sufficient magnitude to constitute a risk of electric shock to persons.



The exclamation point within an equilateral triangle is intended to alert the user to the presence of important operating and maintenance (servicing) instructions in the literature accompanying the appliance.



Marking by the "CE" symbol (shown left) indicates compliance of this device with the EMC (Electromagnetic Compatibility) and LVD (Low Voltage Directive) standards of the European Community.



DETAILED SAFETY INSTRUCTIONS:

All the safety and operation instructions should be read before the appliance is operated.

Retain Instructions:

The safety and operating instructions should be retained for future reference.

Heed Warnings:

All warnings on the appliance and in the operating instructions should be adhered to.

Follow Instructions:

All operation and user instructions should be followed.

Water and Moisture:

The appliance should not be used near water (e.g. near a bathtub, washbowl, kitchen sink, laundry tub, in a wet basement, or near a swimming pool etc.).

Ventilation:

The appliance should be situated so that its location or position does not interfere with its proper ventilation. For example, the appliance should not be situated on a bed, sofa, rug, or similar surface that may block the ventilation openings, or placed in a built-in installation, such as a bookcase or cabinet that may impede the flow of air through the ventilation openings.

Heat:

The appliance should be situated away from heat sources such as radiators, heat registers, stoves, or other appliances (including other amplifiers) that produce heat.

Power Source:

The appliance should only be connected to a power supply of the type described in the operating instructions or as marked on the appliance.

Grounding and Polarization:

Precautions should be taken so that the grounding or the polarization means of the appliance is not defeated.

Power Cord Protection:

Power supply cords should be routed so that they are not likely to be walked on or pinched by items placed upon or against them, paying particular attention to cords and plugs, convenience receptacles and the point where they exit from the appliance.

Cleaning:

The appliance should only be cleaned as recommended by the manufacturer.

Non-use Periods:

The power cord of the appliance should be unplugged from the outlet when left unused for a long period of time.

Object and Liquid Entry:

Care should be taken so that objects do not fall and liquids are not spilled into the enclosure through openings.

Damage Requiring Service:

The appliance should be serviced by qualified service personnel when;

- The power supply cord or the plug has been damaged; or
- Objects have fallen, or liquid has been spilled into the appliance; or
- The appliance has been exposed to rain; or
- The appliance does not appear to operate normally or exhibits a marked change in performance; or
- The appliance has been dropped, or the enclosure damaged.

Servicing:

The user should not attempt to service the appliance beyond what is described in the Operating Instructions. All other servicing should be referred to qualified service personnel.

INTRODUCTION

The M-60 Xd is a high-resolution monitoring system designed for mixing, editing and mastering. The M-60 Xd employs DEQX calibration, a proprietary dsp correction system that corrects frequency and time domain response in real time. In addition, the system offers almost “brick wall” digital crossovers (up to 300dB per octave) and does all processing with latency less than 10ms making it useful for film production as well as music. The benefit to the audio professional is a wider sweet spot, a higher output system and dead-on accurate reproduction.

The system includes a pair of monitors and a dedicated, outboard processor amplifier. The uniquely shaped cabinet is ideally designed for near-field listening. The wide baffle around the tweeter promotes even power response, and the narrow baffle surrounding the woofer reduces midrange reflections and reduces cabinet resonance. The lack of parallel surfaces on the cabinet minimizes the formation of internal standing waves. The drivers employed in the M60 monitors are designed for power handling and extremely low non-linear distortion.

The XdA amplifier/processor houses the DEQX DSP processor, switching power supply and four 150W, class D amplifiers. The system is bi-amplified, each amplifier is dedicated to a single driver in the system.

The M-60Xd can be used as a stand alone monitor pair or be mated with the NHT S-80 subwoofer for a full range system. The M-60 Xd offers accuracy previously unknown in the loudspeaker universe. The system has a frequency response of +/- 0.5dB from 55Hz - 20kHz, with distortion less than 0.3% above 100Hz at 90dB SPL.

The M-60 Xd is shipped with factory preset filters. The system is as future-proof as we can make it. As we develop new filters and other uses for the DEQX DSP engine, you can upgrade your system via the USB2.0 port found on the back of the XdA.

Unpack all cartons:

Check Contents with Packaging Contents list below:

Loudspeaker Carton

- Loudspeaker



Accessory Box:

- 20' 4-conductor speaker wire with quad banana plugs on both ends
- Rubber Pads



XdA Carton:

- Integrated Digital Amplifier
- Power Cord
- This Manual



XdA PLACEMENT

The XdA is designed to be placed on a shelf or table. It should never be placed on a carpeted surface as this will affect the airflow coming into the unit on the bottom side. The feet should never be removed from the bottom of the unit. The XdA can be rack mounted with the aid of a rack pan or tray. At this time we do not have a rack ear option available for it.

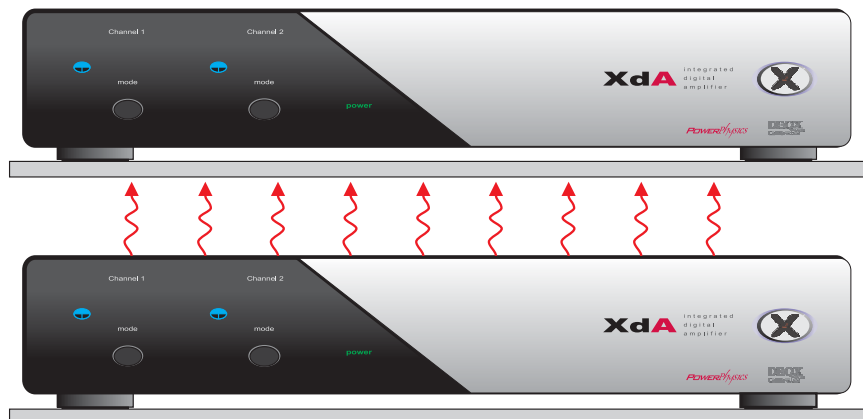

Before making any connections, make sure that all devices in the system are turned off. Connect the output of your mixer, preamplifier or soundcard to either the RCA or XLR inputs. The inputs are wired in parallel, so only one set of inputs should have patch cords connected to them at a time. The XLR inputs are wired as shown below.

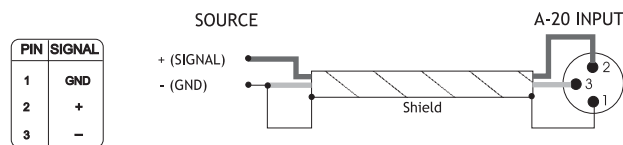

Fig. 3b Unbalanced Wiring Diagram

The XdA utilizes a switching power supply that automatically senses the incoming AC line voltage and adjusts accordingly. The range of AC voltages it can be used with is from 90-260VAC. There are no external fuses or switches that need to be changed when moving the unit from one country to another.

A grounded power cord must always be used with the XdA. **Never** lift or break the ground connection. If your system installation has hum problems, fix the ground loop the proper way at the signal level connections. Excellent information on these problems and how to fix them are available at the Jensen Transformer's website, www.jensentransformers.com, under the white paper section.

M-60Xd SPEAKER CONNECTIONS

The M-60 Xd system comes with a pair of 25' long 4-conductor speaker wires to connect the XdA to M-60 Xd speakers. Each end of the wires is pre-terminated with a quad banana plug. These banana plugs are lettered A, B, C, D to indicate the correct polarity for installation on the XdA and M-60 Xd end. Simply plug the wire in at each end observing the correct polarity.

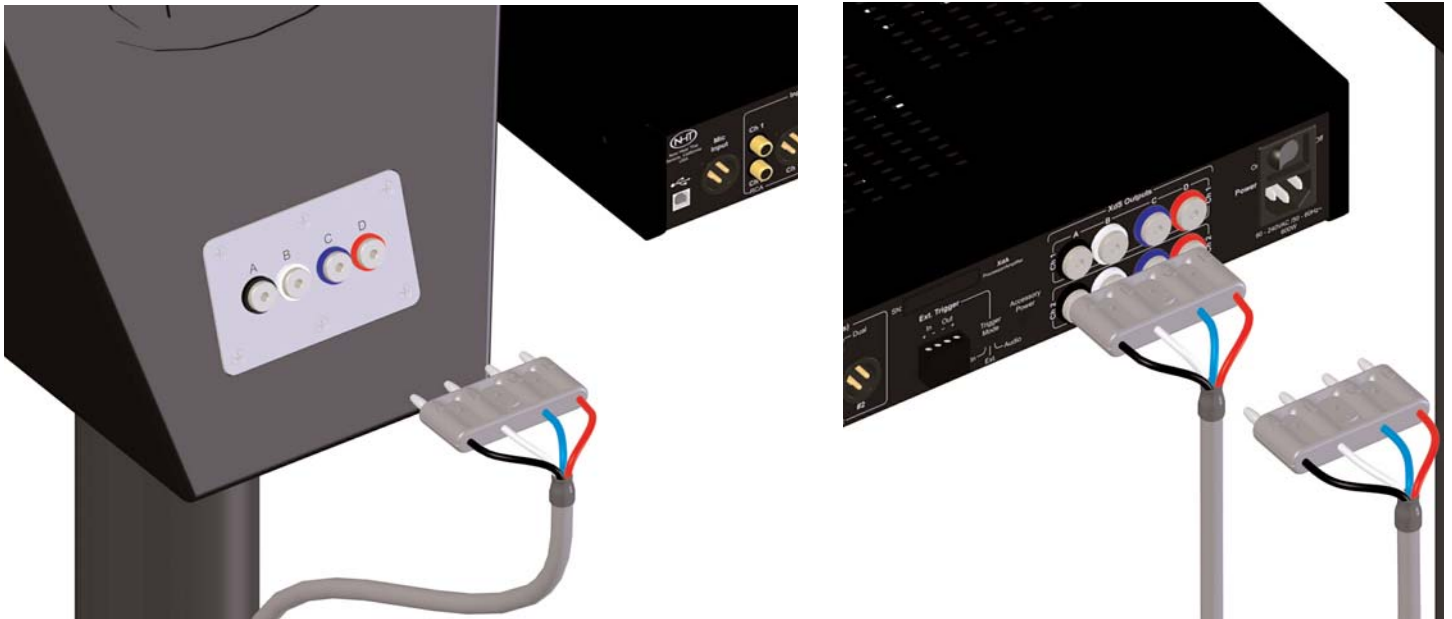

If you need a longer wire run between your XdA and M-60 Xds, there are a couple of options. You can purchase quad banana plug kits and bulk wire directly from NHT or fabricate your own. To facilitate your own harness construction, the A and B terminals of the quad banana plugs are spaced on standard 3/4" banana plug/binding post dimensions, as are the C and D terminals. The B and C terminals are not spaced on 3/4" centers. Standard dual banana plugs can be plugged into the A-B and C-D terminals. If you fabricate your own harness, make absolutely sure to connect the A terminal on the XdA to the A terminal on the M-60 Xd. Do the same for the B, C and D terminals. Misconnecting the terminals can result in serious damage to the M-60 Xd speaker.

Optional S-80 SUBWOOFER

If you are using an S-80 subwoofer with your M-60 Xd system, connect the supplied XLR patch cord from the #1 XdW output on the back of the XdA to the input on the S-80 subwoofer. Set the XdW output switch on the back of the XdA to the Single subwoofer position.

If you are using two S-80 subwoofers with your M-60 Xd system, connect the first S-80 to the #1 XdW output and the second S-80 to the #2 output. Set the XdW output switch to the Dual position.

Single Subwoofer



Dual Subwoofer

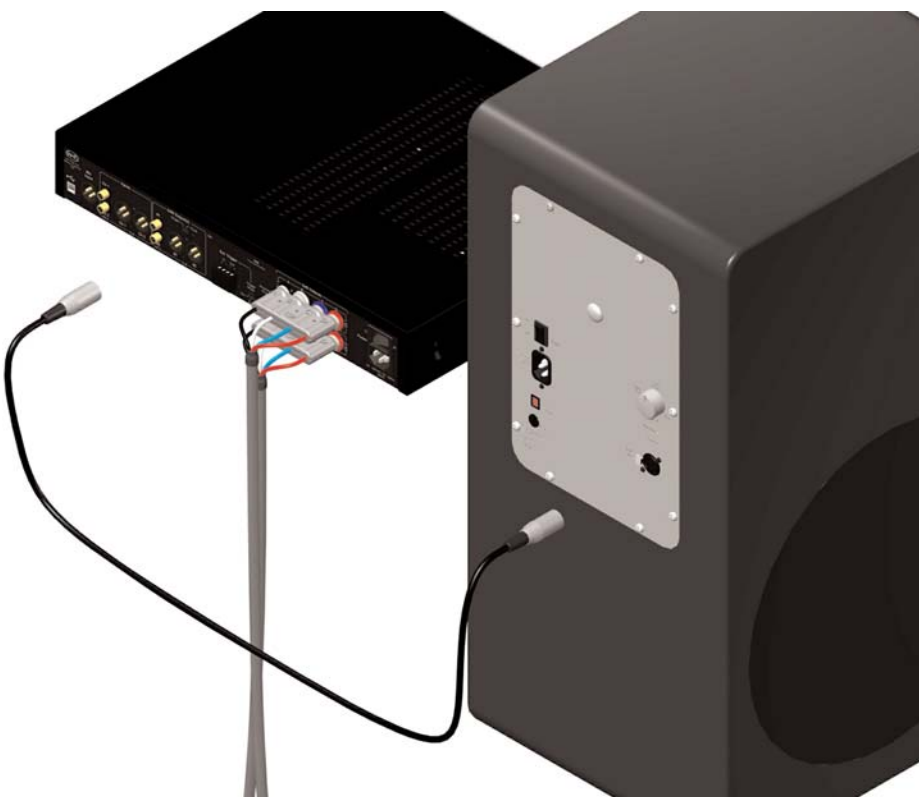

For correct operation of your system with the S-80 subwoofer, you must have a subwoofer compatible filter set loaded into the XdA. For information on this, see your S-80 manual or contact NHT.

SYSTEM CONTROLS

Power Switch:

The main AC power switch is located on the rear panel by the IEC inlet socket for the AC power.



Trigger Control:

The XdA power status can be controlled several different ways through the External Trigger switch located on the rear panel. When the Trigger Mode is set to On, the XdA power will always be on. When set to Audio, the XdA will automatically power up whenever it detects an audio signal at either of the inputs. When set to Ext., the XdA will power up whenever it detects a 12VDC signal at the External Trigger input. When the XdA powers up from the power switch or any of the trigger sources, there may be a slight tick heard through the speakers. This is normal.



SPEAKER MODE:

The XdA is programmed with four different filters for each of the two channels. Each of these filters is designed for a particular application or acoustic setting. For example one filter might have a bass rolloff at 80Hz for use with a subwoofer. Another filter may have rolled off high frequencies to compensate for a very reflective room, while another may cut the low frequencies of the M-60 Xd sharply to allow it to produce higher SPLs. The combination of these eight filters is called a filter set. Contact NHT or visit our website at www.nhthifi.com to find out what other filter sets are available for your M-60 Xd system.

The ability of the M-60 Xd system to change performance characteristics simply by changing the filter set is one of the great advantages of DSP processing that the M-60 Xd system offers. What follows below is a description of the stock filter settings in the M-60 Xd system as shipped from NHT and how to access them.

Each filter setting is accessed by the mode buttons on the front panel of the XdA. The left mode button accesses the four filters for channel 1, the right button accesses the filters for channel 2. To change the filter setting for one of the channels, simply depress the mode button for that channel until the appropriate icon is illuminated. The top icon is for filter setting #1, the next icon down is for filter setting #2 and so forth.

Set 1:

In this filter setting, the system has a flat frequency response that rolls off slowly below 70Hz.

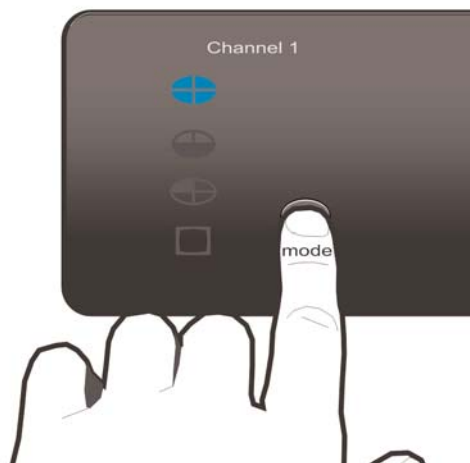

Set 2:

In this filter setting, the system has a flat frequency response that rolls off sharply below 45Hz.

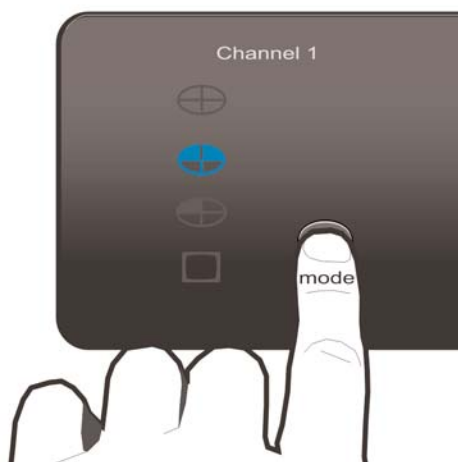

Set 3:

In this filter setting, the system has a flat frequency response that rolls off sharply below 45Hz and a 1dB depression from 2-6kHz.

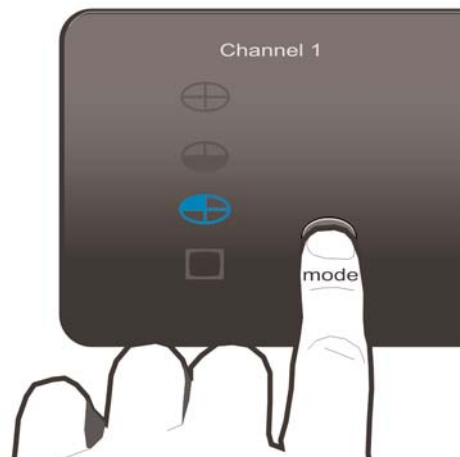

Set 4:

In this filter setting, the system has a flat frequency response that rolls off sharply below 45Hz and a 1dB shelving above 2kHz. (See the specifications page for details of the frequency response differences.)

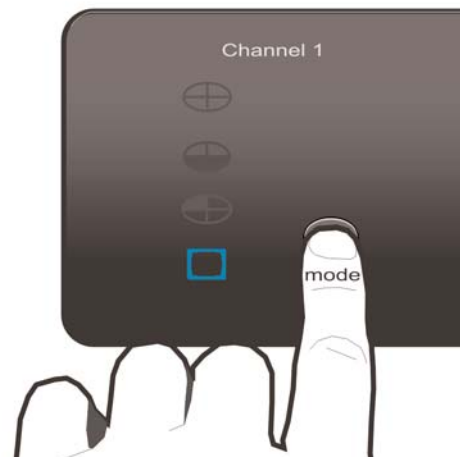

LOCKOUT MODE:

If neither mode button is depressed for several minutes, most of the front panel illumination turns off and the mode buttons become inactive. This feature serves several purposes. It saves power, reduces ambient light when doing video work, and most importantly keeps prying fingers from messing with your controls! To gain access to the mode functions again, depress both mode buttons for several seconds until the front panel illuminates again.

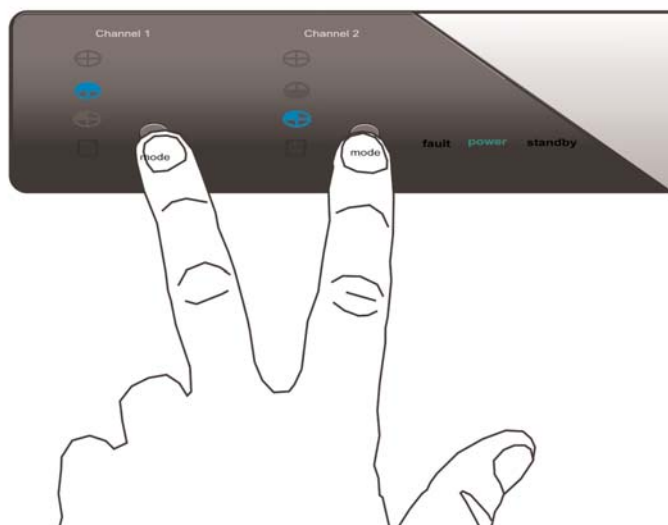

FRONT PANEL ICONS:

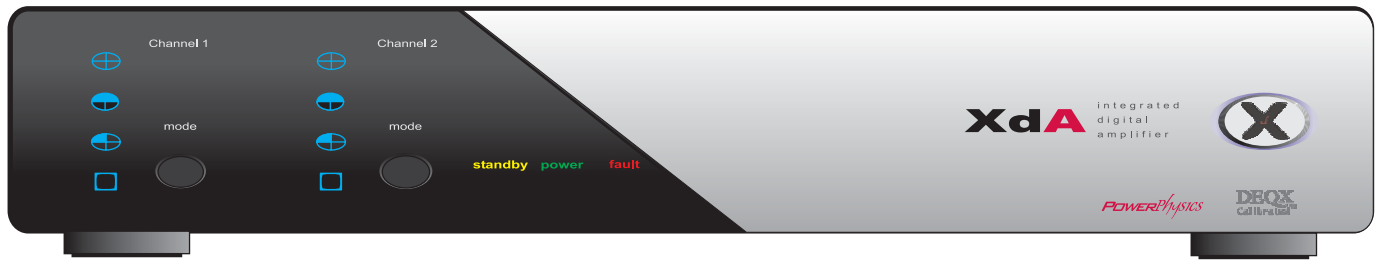

Standby:

This text illuminates whenever the XdA is in standby. See the Trigger Control section for more details.

Power:

This text illuminates whenever the XdA is powered up and operational.

Fault:

This text illuminates whenever the XdA detects a fault condition. There are several situations that can cause this.

If one of the speaker outputs is shorted to each other or ground, the fault light will stay on until the condition is fixed and the XdA is power cycled. The amplifier channel with the shorted speaker wire will remain muted until the condition is fixed.

If any of the amplifiers has excessive DC at its output, the fault light will remain on and that channel will remain muted.

If any of the amplifiers' temperature gets too high for safe operation, the fault light will illuminate and that channel will mute. To fix the condition, the amplifier must cool off at least 10 degrees C and then be power cycled.

If any of the amplifiers are driven into clipping, the fault light will flash during clipping. If the amplifier is driven into clipping excessively, the over current protection will trip and that channel will mute. To reset this protection, power cycle the XdA.

SPEAKER PLACEMENT:

The M-60 Xd Monitor System is intended to provide consistent performance over a wide range of placement situations. This is accomplished through the use of electrical controls, wide dispersion drivers, advanced enclosure design and carefully chosen crossover characteristics. Nevertheless, it is always worth investing time and effort experimenting with optimum loudspeaker placement. In all cases, the M-60 Xd Monitors should be set up the same distance from the listening position (see fig. 8 below). This is important in order to insure equal arrival time of all channels to the listening position. Ideally, the tweeter height on the M-60 Xd monitor, as with all channels, should be on axis with your ears, or slightly above. Also, remember that nearby reflective surfaces (including video monitors) can alter impulse response, blur imaging and change tonality; giving the M-60 Xd as much room as possible assures the highest-quality reproduction.

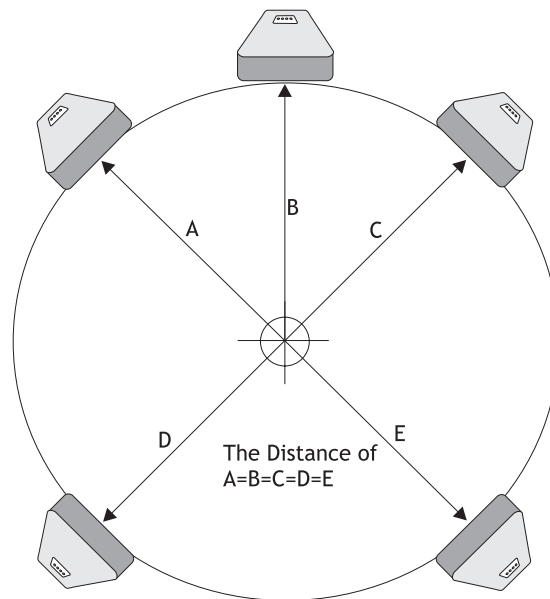

Fig. 8 Ideal 5.1 Surround Monitor Placement

SYSTEM OPERATION:

The M-60 Xd is capable of very high output levels, especially when listening in the near field. Still, every speaker system has its limits. Harsh breakup at extremely high volume, or heat emanating from the drivers is an indication that the system has exceeded its output limits and that you should lower the playback level. Watch for excessive lighting of the front panel overload indicator on the Control Amplifier. Speaker damage most often occurs from sustained high volume levels, not from transient sounds or brief musical peaks. Protect your ears and use common sense.

M-60 Xd MONITOR SYSTEM CARE:

Except for the occasional flattering comment, your M-60 Xd System needs no regular maintenance. Never attempt to clean the M-60 Xd Monitor driver units except for very light feather dusting. The M-60 Xd Monitor cabinets and the M-60 Xd Control Amplifier front panel can be cleaned using a damp, soft cotton cloth, first sprayed with a mild, non-abrasive glass cleaner and with the unit unplugged and AC power off. Never spray the speaker or amplifier directly! Avoid silicone and oil based cleaners or treatments.

NEED SOME HELP?

Technical Support can be reached several ways: Telephone us 800-NHT-9993 (648-9993), E-mail us at: tech@nhtpro.com, Fax us at: (707) 747-1252 or write us at: NHT, 6400 Goodyear Rd. Benicia, CA 94510. Visit our web site at www.nhtpro.com for more info and product updates.

SYSTEM SPECIFICATIONS:

Monitor:

Type: DSP corrected/powerd near/midfield monitor

Configuration: 2-way, Acoustic Suspension

Woofers: 6.5" magnesium cone, super linear motor

Tweeter: 1" aluminum dome, textile surround, ferrofluid cooled

Magnetic Shielding: Full

Loudspeaker Dimensions: 15" x 13" x 10"

Weight: 17.5 lbs.

Loudspeaker Materials: Machined MDF of various thicknesses

Amplifier/DSP processor:

Amplifier Power: 150W RMS x 4, 300W x 4 peak

Peak Acoustic Output: 112dB SPL (100ms pink noise at 1M)

Residual acoustic noise: <15dB SPL @1M

System THD @90dB SPL: <0.3% (100Hz-20kHz @1M)

Frequency Response: 55Hz-20kHz +/-0.5dB

-6dB LF cutoff: 40Hz

Amplifier/DSP processor dimensions: 3.5" x 19" x 13.375"

Amplifier/DSP processor weight: 12.5lbs

Features/Controls:

Input XLR, RCA

Output to Subwoofer: XLR, RCA

Output to monitor: Quad banana plug

Controls:

Filter setting

Number of subwoofers

Display:

Standby

Power

Fault

XdA ARCHITECTURE

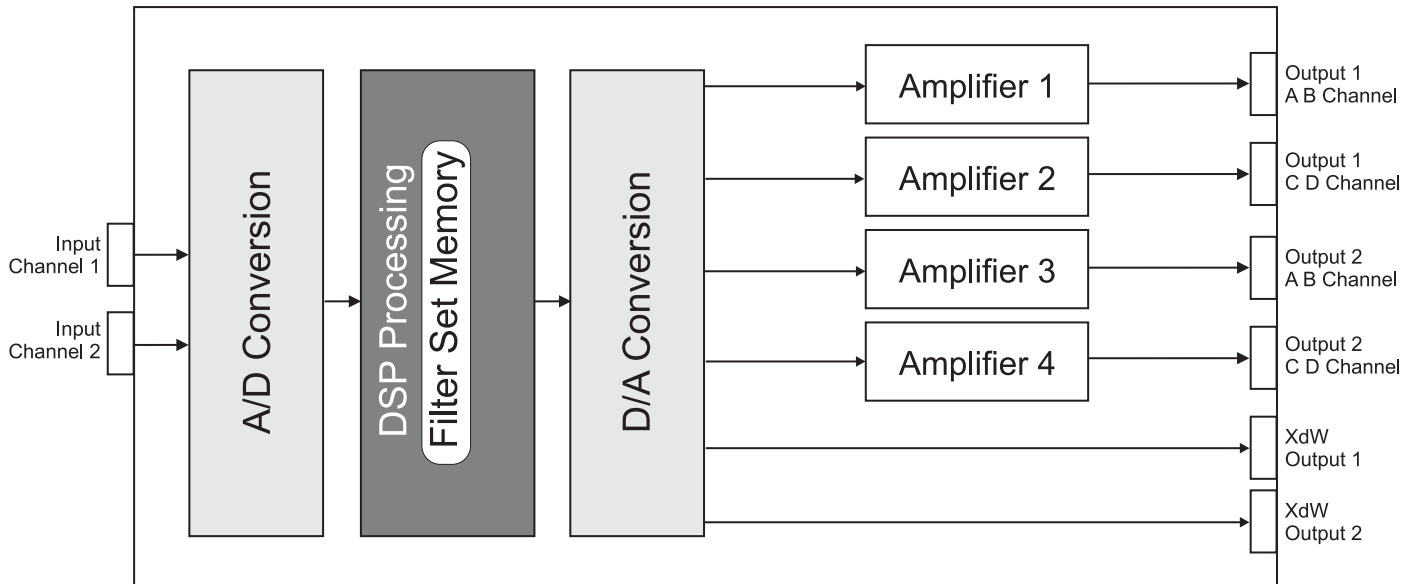

Limited Warranty Valid Only in the U.S.A.

Warranty Period

For a period of 3 years for parts and 3 years for labor from the date this product is first purchased from an authorized NHT dealer, Now Hear This (NHT) warrants that if it fails to function properly due to a manufacturing defect, despite its being installed and operated according to these instructions and used under normal conditions, it will be either replaced or repaired with new or rebuilt parts (both at NHT's option) with a unit of comparable value without charge to you.

What's Not Covered

Altered, defaced or removed serial numbers void this warranty.

This warranty does not cover any product used in trade, business, industrial or commercial applications.

This warranty also does not cover the cabinet or appearance factors, or costs, defects or damage resulting from misuse, abuse, accident, improper maintenance, alterations or modifications not authorized in writing by NHT, or parts or labor from any source other than an authorized NHT service location.

Damage due to power exposure in excess of the speaker's published power ratings; ie, overpowering, lightning or power surges, are also not covered.

Your Rights

This warranty gives you specific legal rights, and you may have other rights which vary from state to state.

NHT limits this warranty to the purchase price of the product, excludes incidental or consequential damages, and limits its obligations under any implied warranties under state laws to a period not exceeding their warranty periods. As some states do not allow the above limitations, however, they may not apply to you.

To Obtain Service

To find the name and address of the nearest authorized NHT service location, call or write:

Customer Service Department, NHT, 6400 Goodyear Rd., Benicia, CA 94510, 1-800-NHT-9993 (648-9993), www.nhthifi.com

For your future convenience, please keep this warranty with your sales receipt, and record date and place of purchase for further reference.